



Lithium-Ion Battery Storage Fundamentals

AUTHORS

Michael Kozich
Senior Staff Engineer

Hakeem A. Dairo
Product Manager

INTRODUCTION

Can today's power generation keep up with tomorrow's power consumption? Many experts believe this will not be possible, and to avoid costly transmission and power generation costs, utilities and customers are looking towards renewables to assist in shouldering the load. Renewable energy sources are a great way to increase energy production while reducing our carbon footprint and carbon emissions.

Solar and wind energy sources are great renewable options but have their shortcomings: both are geographically dependent and do not always produce power. To combat this unpredictability in production, customers can pair their renewable assets with energy storage. One method is to oversize the solar energy system and allow the energy storage to capture this excess in production. This affords the customer to then use their energy storage for various use cases such as voltage and frequency stability in situations where the utility is unstable or provide relief on their utility bill.

The purpose of this white paper is to introduce lithium-ion batteries, which are one of the most installed battery systems in the world today.

LITHIUM-ION BATTERY STORAGE

WHAT IS LITHIUM-ION BATTERY STORAGE?

This technology incorporates numerous lithium-ion (li-ion) battery cells wired together to achieve the customer required system voltage and power rating. To ensure proper safety and operating conditions for the batteries, other components and sub systems are required.

Figure 1 details the major components of a stationary lithium-ion battery storage energy system.

Figure 1

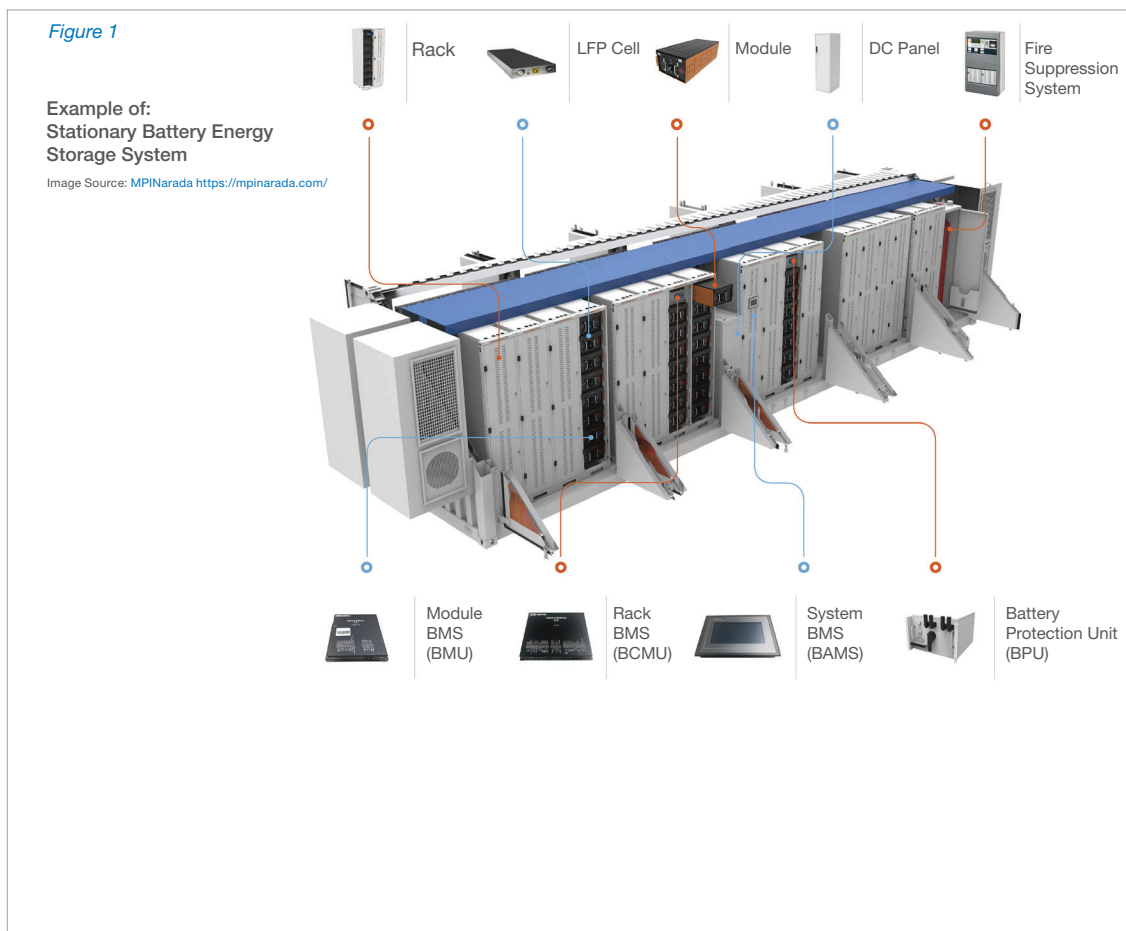

Example of: Stationary Battery Energy Storage System

Image Source: MPINarada <https://mpinarada.com/>

LI-ION CELL FORMAT

The cell is the basis by which the energy is stored in the battery. It is the part of the battery system which performs the function of storage and can come in different shapes and sizes with the most popular ones being cylindrical, prismatic, and pouch formats.

The format used in different battery systems is chosen primarily to achieve various benefits during battery system design and development including improved energy densities as well as mechanical and thermal performance. See Figure 2.

CYLINDRICAL

The cylindrical cell continues to be one of the most widely used packaging styles for primary and secondary batteries. This is a format which most people will recognize as looking like the AA and AAA alkaline batteries that go into devices such as your TV remote.

The advantages are ease of manufacture and mechanical stability, but they tend to be limited on the current carrying capability relative to other formats—something that is becoming less of an issue as they are now being produced in larger formats. 18650s and 21700s are commonly manufactured sizes, named according to their physical dimensions.

POUCH

The pouch cell offers a light and simple solution to ensure flexibility in pack design. Pouch cells can deliver high-load currents, but considerations need to be made about potential swelling which can occur in these cells through their operating life.

PRISMATIC

The prismatic cell provides a more structural housing which improves mechanical robustness and satisfies the demand for modular systems. Some designs are more layered while others are wound and flattened into some sort of jelly roll. There is huge variety in the size of these cells to support system design flexibility.

Figure 2

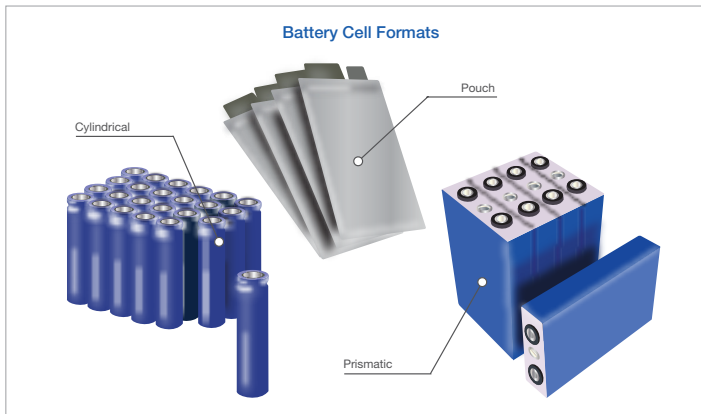

CELL CHEMISTRIES

VARIETY OF CHEMISTRIES

Lithium-ion (li-ion) cells come in a variety of chemistries which provide different performance benefits to the overall battery system. They are named based on the active materials used in the chemistry, and the words are either written in full or abbreviated, as shown in *Figures 3 and 4*.

In this white paper, we will look at two common chemistries seen in the market today, one being the more energy dense nickel manganese cobalt (NMC) and the other "safer" lithium iron phosphate (LFP) chemistry.

Primarily LFP provides an inherent safety quotient which isn't available with NMC, but the energy density in NMC far outperforms that of LFP.

LITHIUM NICKEL MANGANESE COBALT OXIDE (NMC) LiNiMnCoO_2

NMC offers two major advantages as compared to the other cell types. The first one is its high specific energy, which makes it more common in vehicles and bikes, where space is at a premium. Another is its performance balance, see *Figure 3*, in relation to other performance indicators like specific power, safety, life span, and performance when compared to the other lithium-ion chemistries.

Figure 3

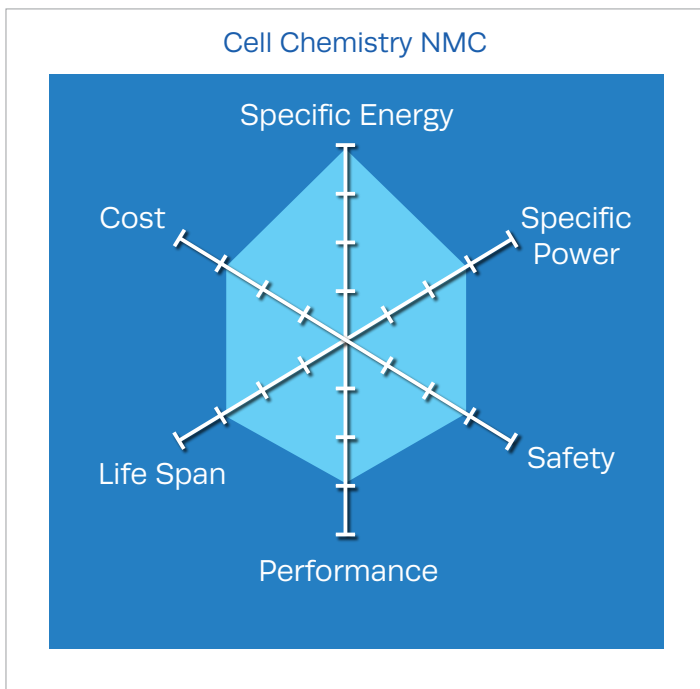

LITHIUM IRON PHOSPHATE (LFP) LiFePO_4

LFP, as shown in *Figure 4*, has grown significantly in recent years and offers the benefits of lower cost and improved safety as compared to other cell chemistries.

One major disadvantage is its low specific energy, which does not make it a good option in certain applications where space is not readily available.

Other than that, it has moderate to high ratings in all the other characteristics including high specific power and long life span.

Figure 4

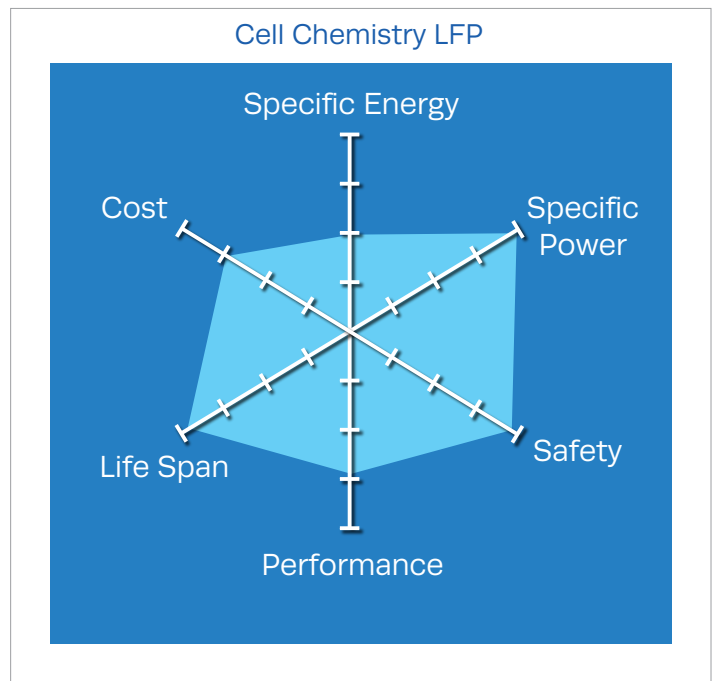

WIRING OF CELLS

TYPES OF CONNECTION

Cells are connected in series and parallel to increase the voltage and/or current ratings of the overall battery system.

SERIES CONNECTION

The battery system voltage is increased when cells are connected in series. Reviewing *Figure 5* below, if you need a voltage of 12 V, then connect the batteries in series for a system which provides a total of 14.4 V. Note that the end voltage does not need to exactly match as long as it's higher than what the powered device requires as most devices can withstand the slight difference.

Figure 5

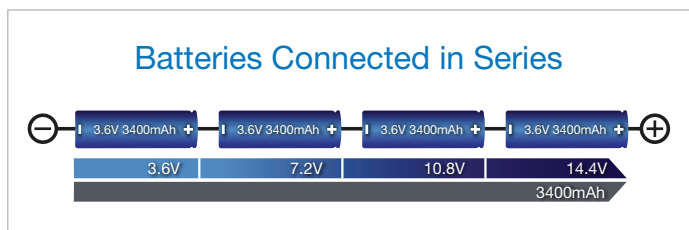

PARALLEL CONNECTION

The system current carrying capability is increased when you connect in parallel as shown in *Figure 6*. If higher currents are needed but there isn't a drive to increase cell size, then the cells are strung in parallel.

Note:

A cell that develops high resistance or "opens" is less critical in a parallel circuit arrangement than in a series configuration, but a failing cell will reduce the total load carrying capability. An electrical short "closed", on the other hand, is more serious as the faulty cell drains energy from the other cells, potentially causing a fire hazard.

Figure 6

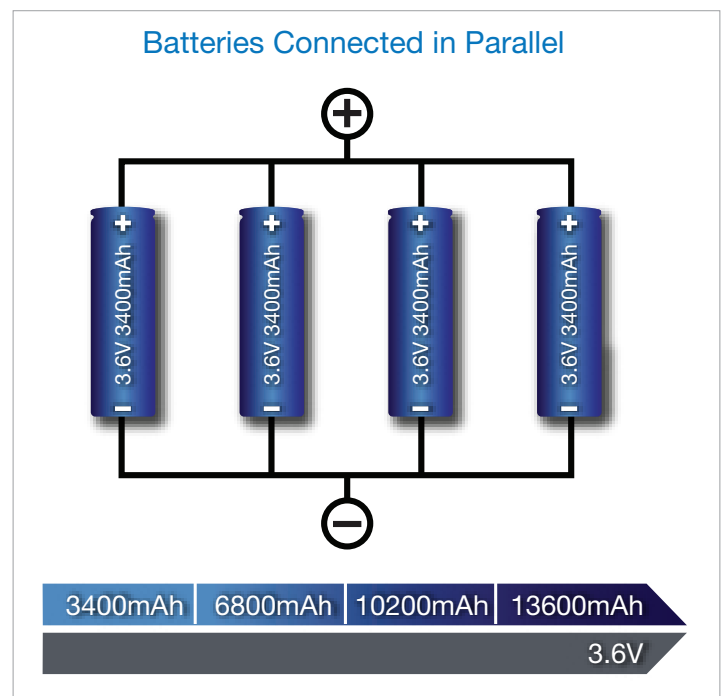

WIRING OF CELLS (CONT.)

SERIES / PARALLEL CONNECTION

The series/parallel configuration shown in *Figure 7*, ensures the required voltage and current for the whole battery system can be met. The total power is the sum of voltage multiplied by current ($P= IV$ Therefore four cells connected in series and parallel will produce a total of 48.96 Wh. An arrangement of eight cells will produce 97.92 Wh.

The cells need to be monitored to stay within voltage and current limits. This is achieved through custom circuits, otherwise referred to as the battery management system.

Figure 7

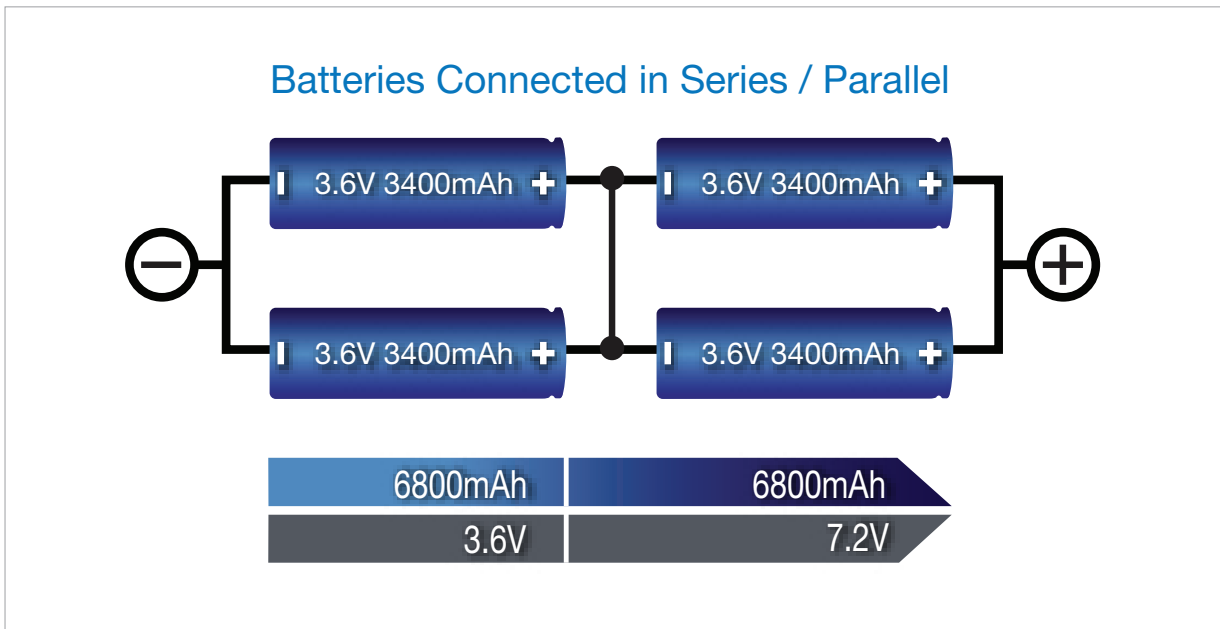

BATTERY STORAGE SYSTEM

COMMON METRICS

The following are common metrics that define battery storage systems and need to be considered when designing a battery storage system for a customer.

DISCHARGE C-RATE

Specifies the maximum power discharge of the battery storage system (per hour). For example, if the rated energy of the system is 2 MW and the C-rate is 1C. The system can discharge 2 MW of power over one hour. The system can also discharge lower amounts of power for a longer period, for instance 1 MW for two hours. If the C-rate of the system is 2C, the system can discharge 4 MW over 30 minutes.

Design Consideration: The battery storage system should be oversized due to battery degradation over time termed capacity fade, but this would depend on the loading requirements and the contractual agreement of the system.

CHARGING C-RATE

Charging C-rate specifies the maximum charging rate of the batteries. A C-rate of 0.5 C quantifies a two-hour duration to fully charge the batteries. A C-rate of 1C quantifies a one-hour duration to fully charge the batteries.

RATED VOLTAGE (V)

Rated voltage specifies the electric potential of the battery system, expressed in direct current (DC). In a battery system, voltage measurements can be provided from different perspectives: cell, module, rack, system. Generally, the battery supplier will specify the voltage of a rack and system.

Design Consideration: The designer will need to verify the battery system voltage range (min./max.) is within the Inverter (min./max.) range. There is a range for the battery system because as a battery discharges the voltage drops. When the battery is fully discharged, this can be referred to as the open circuit voltage.

CAPACITY (Ah)

Capacity in amp-hours (Ah) specifies the amount of current a battery can deliver over a specified duration. Generally, this metric is specified over one hour of discharge.

Design Consideration: Depending on the discharge C-rate of the battery system, cable sizing needs to be considered. Even though the capacity could be 100 Ah, if the battery allows a higher C-rate for a short duration, the battery system can exceed this 100 Ah cable rating and potentially double that value.

RATED ENERGY (kWh)

Rated energy (kWh) specifies the total amount of energy capacity for a battery system. This energy can be drawn out of the battery system at different specified rates (C-rate). This rate will determine the amount of instantaneous power the system can discharge at a given time.

RATED POWER (kW)

Rated power (kW) specifies the amount of instantaneous energy the battery storage system can discharge. This specification is not always given and can be derived from the discharge C-rate and the rated energy of the battery storage system.

One negative effect that can occur from higher discharge rates of batteries (C-rate greater than 1) is a quicker battery degradation of the cells and could affect the warranty period.

Risk analysis would need to be considered during system design and use cases.

STATE OF CHARGE (SoC)

CALCULATED BY THE BATTERY MANAGEMENT SYSTEM

The state of charge (SoC) is calculated by the battery management system (BMS). This calculation will measure the remaining capacity of the battery storage system in percent. There are a couple of ways to calculate SoC.

FIRST METHOD OF CALCULATION

The SoC of the system can be estimated based on the voltage of the battery cells. The battery supplier will provide a voltage discharge curve and the x-axis can be in capacity or energy. Based on the voltage of the y-axis the BMS can determine how much current or energy has been discharged. As you can see below in *Figure 8*, different discharge rates can have an effect on the battery voltage.

Figure 8

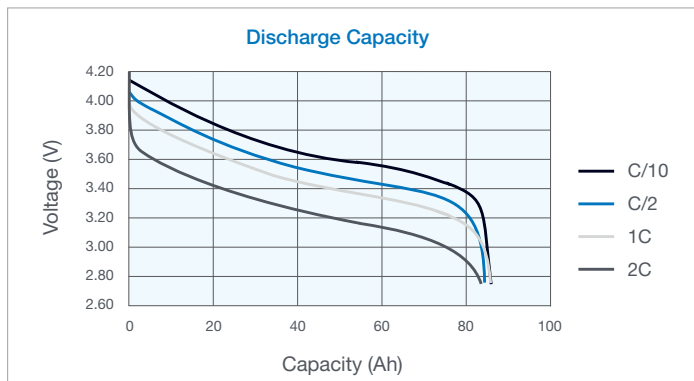

Reference: Cadenza Innovation, Super Performance Overview

SECOND METHOD OF CALCULATION

The second method to calculate SoC is the method of coulomb counting. This method can be the preferred method due to the discharge curve of battery chemistries. Certain battery chemistries have a very flat discharge curve between 30–70% of the SoC and it can be difficult to determine the SoC based on the voltage of the cells. The following formula is utilized for coulomb counting. See *Figure 9*.

Figure 9

$$\text{SoC}(t) = \text{SoC}(t-1) + \frac{I(t)}{Q_n} \Delta t$$

- SoC(t) is the calculated SoC
- SoC(t-1) is the initial SoC prior to starting to discharge the battery
- I(t) is the current at time instant t and will be a negative value
- Q_n is the rated capacity of the battery in ampere hours
- Δt is the time step, for instance 1-hour

STATE OF HEALTH (SOH)

State of health (SoH) is a battery management system (BMS) calculation of the maximum remaining capacity of the battery as compared to the initial rated capacity. See *Figure 10*.

Figure 10

$$\text{SoH}/\% = 100 \frac{Q_{\max}}{C_r}$$

- SoH is the calculated State of Health
- Q_{\max} is the current maximum charge of the battery
- C_r is the rated capacity of the battery

CYCLES

Cycles are an estimation of how many times a battery system can go from a charged state to a discharged state. Cycles vary on the type of battery chemistry, but it is common to achieve 4,000 to 6,000 cycles for a battery system. If a system is exercised once per day, you could achieve over a ten-year life cycle for the battery system.

Many factors of the battery system can lead to a negative effect on the cycle life. These can include the temperature of the cells and the depth of discharge. Batteries suppliers recommend not discharging the battery system to a 0% SoC, but this factor needs to be weighed against the use case needing to be executed. A full discharge infrequently will not hurt the battery system but frequently performing a full discharge will have a negative effect.

GRAVIMETRIC ENERGY DENSITY (WH/KG)

Gravimetric energy density is a calculation of how much energy per unit mass for a battery cell. This metric is important in relation to utilizing batteries within moving objects (cars, fork trucks).

VOLUMETRIC ENERGY DENSITY (WH/L)

Volumetric energy density is a calculation of how much energy per unit volume for a battery cell. This metric is important in relation to the size required for energy storage.

The smaller the number the more square footage or height required to house the battery storage system. This metric can make a big impact for enclosure or when battery storage will be stored indoors.

BATTERY MANAGEMENT SYSTEM (BMS)

BMS FOR BATTERY SAFETY AND FUNCTIONALITY

The BMS is integral to maintaining functionality and safety of the battery cells. Typical BMS modules can monitor and control 12–16 cells.

Cells are directly wired into the BMS module and will monitor the voltage and temperature of each cell. Cell temperature is critical for battery performance and is utilized by the thermal management system to control the heating/cooling of the battery storage section.

Voltage monitoring is critical for estimating the SoC of the battery cells and is utilized for equalizing the SoC of all the cells connected to the BMS.

CELL BALANCING

THE ROLE OF THE BMS

Throughout the process of charging and discharging of the battery system, each cell within the module can be at different SoC percentages. This is due to manufacturing processes and physical properties of the battery cells being intrinsically different.

Also, while at steady state, batteries self-discharge which leads to battery cells being at different SoC. This difference in charged state requires the use of an external system to monitor and manage the state of charge for each cell. This role is served by the BMS while monitoring the voltage of the cell, and while the battery system is in a resting state the BMS will manage the charging of the battery cells.

Battery charging can be performed from two techniques: passive and active cell balancing.

PASSIVE CELL BALANCING

Passive cell balancing is a BMS technique that matches all cells to the cell with the lowest state of charge. Passive balancing requires each cell to have a resistor and a contact. *See Figure 11.*

When passive balancing is active and the cell is not the cell with the lowest SoC, the contact closes and dissipates energy across the resistor.

PASSIVE BALANCING PROS

- Inexpensive
- Minimal parts

PASSIVE BALANCING CONS

- Wasting energy
- Inefficient

Figure 11

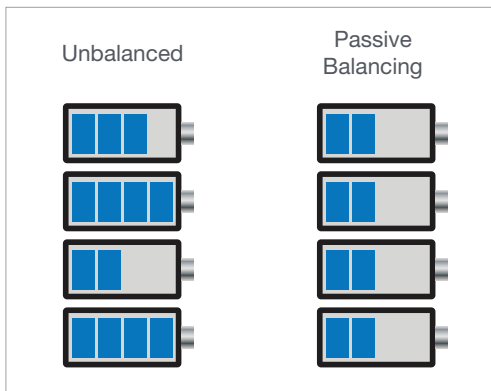

ACTIVE CELL BALANCING

Active cell balancing is a BMS technique that evenly distributes all cell SoC. Energy of the higher cells is transferred to cells with a lower state of charge. This is performed by using capacitive or inductive integrated circuits. *See Figure 12.*

ACTIVE CELL BALANCING PROS

- Can balance cells during discharging
- Highly efficient

CELL BALANCING CONS

- Increased costs
- Increased space requirements
- More components lead to increased potential for failures

BMS MONITORING CELL VOLTAGE AND TEMPERATURE

A BMS will directly connect to cells to monitor voltage and temperature. An accurate temperature is critical to maintaining safety of the battery storage system.

BMS DESIGN REQUIREMENTS

- Maximum number of cells to manage and monitor
- Voltage measurement
- Temperature measurement
- Disconnect batteries during unsafe conditions
- SoC calculation
- Cell balancing (active vs. passive)

Figure 12

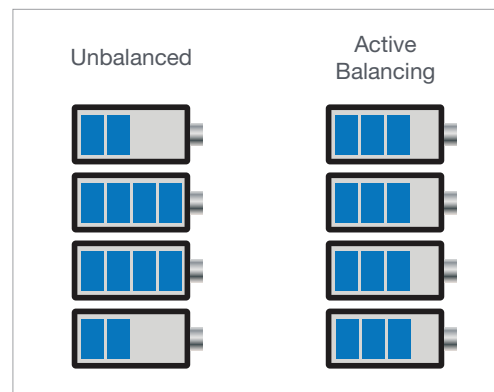

CONCLUSION

Lithium-ion batteries are the dominant choice in energy storage today. These batteries have great energy density that allow for short high power to longer duration applications, covering a wide breadth of use cases.

The energy storage market is ever evolving, and in upcoming years, we will see various innovative materials being used in energy storage systems and advancements in renewable energy technologies which will further improve the systems' safety and reduce the cost for customers.

ABOUT THE AUTHORS



Michael Kozich is a Sr. Staff Engineer at Rehlko Co. He has worked for the company's Energy division since 2007 and specializes in control systems programming and design for critical infrastructure customers. He most recently completed a stretch assignment to research battery storage systems. Kozich has a bachelor of science in electrical engineering from the University of Wisconsin–Milwaukee.

Hakeem A. Dairo currently works as a Product Manager responsible for energy storage technologies at Clarke Energy, a Kohler company. Holding multiple engineering degrees across both the electrical and electromechanical fields, Dairo has spent over six years working with energy storage systems across both the automotive and energy sectors. His career started in the automotive industry designing and specifying high-voltage battery systems applied in electric and hybrid vehicles, before moving into stationary application energy storage systems used in the Power industry. His specialties include battery design, systems engineering, and product strategy.



ABOUT POWER SYSTEMS

Power Systems, Rehlko's largest division, delivers worldwide energy solutions designed to ensure resilience for mission-critical applications of all sizes. Building on more than a century of expertise and dedication, the company offers complete power systems, including industrial backup generators (HVO, diesel, gaseous), enclosures, hydrogen fuel cells systems, automatic transfer switches, switchgear, monitoring controls, genuine parts and end-to-end services. As a global company with service partners in every country, Power Systems provides reliable, cutting-edge technology to keep industries and businesses running.

www.powersystems.rehlko.com

ABOUT REHLKO

A global leader in energy resilience, Rehlko delivers innovative energy solutions critical to sustain and improve life across home energy, industrial energy systems, and powertrain technologies, by delivering control, resilience and innovation. Leveraging the strength of its portfolio of businesses – Power Systems, Home Energy, Uninterruptible Power, Clarke Energy, Heila Technologies, Curtis Instruments, and Engines, and more than a century of industry leadership, Rehlko builds resilience where and when the grid cannot, and goes beyond functional, individual recovery to create better lives and communities, and a more durable and reliable energy future.

